

Influence of Zirconium Additions and Ageing Time on Some Mechanical Properties of (6063) Aluminum Alloy

تأثير اضافات الزركونيوم وزمن التعتيق على بعض الخصائص الميكانيكية لسبيكة الالمنيوم (6063)

Abdalla H. Mihdy Jassim

College of Computer Science & Mathematics
Al-Qadisiya University

Abstract:

The influence of Zr additions and artificial ageing time on some mechanical properties of 6063 alloy has been studied. This study aims to prepare the 6063 alloy containing different amounts of Zr and study the effect of Zr and ageing time on some mechanical properties of 6063 alloy such as Vickers hardness, tensile strength, and impact toughness. The results showed that the addition of 0.2 wt.% Zr to the 6063 alloy improves Vickers hardness and tensile strength by 12.96% and 7.86% respectively at ageing time 6h and improves impact toughness by 8.13% at ageing time 2h. Vickers hardness and tensile strength increase with increasing of ageing time for a certain limit of ageing time. Impact toughness decreases with increasing of ageing time and increases with further ageing time. The specimens with the highest Vickers hardness have the lowest impact toughness. The addition higher than 0.2wt.% Zr gives slight increase in studied properties of 6063 alloy .

Keywords: 6063 alloy, Vickers hardness, tensile strength, impact toughness

الخلاصة:

تم دراسة تأثير اضافات الزركونيوم وزمن التعتيق الاصطناعي على بعض الخصائص الميكانيكية للسبيكة 6063 . الدراسة الحالية تهدف الى تحضير السبيكة 6063 المحتوية على كميات مختلفة من الزركونيوم ودراسة تأثير الزركونيوم وزمن التعتيق على بعض الخصائص الميكانيكية للسبيكة 6063 مثل صلادة فيكرز ، ومتانة الشد ومتانة الصدمة. اظهرت النتائج بان اضافة 0.2% من الزركونيوم الى سبيكة 6063 يحسن من صلادة فيكرز ومتانة الشد بنسبة 12.96% و 7.86% على التوالي عند زمن تعتيق 6h ويحسن من متانة الصدمة بنسبة 8.13% عند زمن تعتيق 2h. زيادة زمن التعتيق يؤدي الى زيادة صلادة فيكرز ومتانة الشد ولحد معين من زمن التعتيق. متانة الصدمة تقل بزيادة زمن التعتيق وتزداد مع الزيادة الاكثر لزمن التعتيق. النماذج التي لها اعلى صلادة تمتلك اقل متانة للصدمة. اضافة اكثر من 0.2% من الزركونيوم يعطي زيادة قليلة في الخصائص المدروسة لسبيكة 6063.

الكلمات المفتاحية: سبيكة (6061)، صلادة فيكرز، متانة الشد، متانة الصدمة.

1. Introduction

Aluminum and its alloy have found applications in many industries due to their excellent properties, such as high strength-to-weight ratios, high thermal conductivity, good corrosion properties and excellent workability [1,2]. The 6xxx-group contains magnesium and silicon as major addition elements. These multiphase alloys belong to the group of commercial aluminum alloys, in which relative volume, chemical composition and morphology of structural constituents exert significant influence on their useful properties [3]. In the technical 6xxx aluminum alloys contents of Si and Mg are in the range of 0.5-1.2 wt%, usually with a Si/Mg ratio larger than one. Besides the intentional additions, transition metals such as Fe and Mn are always present [4]. If Si content in Al alloys exceed the amount that is necessary to form Mg₂Si phase, the remaining Si is present in other phases, such as Al-Fe-Si and Al-Fe-Si-Mn particles [5,6]. The addition of alloying elements to aluminum alloys may produce effects of precipitation hardening(age hardening), solid solution hardening ,dispersion strengthening, grain refining and intermetallic phases [7]. Adding

trace elements to high-strength aluminum alloys can enhance their mechanical properties. It is found that trace elements and aluminum can form dispersoids to improve the recrystallization resistance of aluminum alloys, control the structure of grain boundary etc. These can stop cracks penetration along grain boundary [8]. Zirconium is a well-known grain refiner for aluminum alloys [9] and is usually used as a recrystallization inhibitor and grain refiner in commercial aluminum alloys. However, even very small additions of Zr could produce a significant precipitation hardening response. This is due to the precipitation of Al_3Zr meta-stable particles . The Al_3Zr meta-stable phase has the same structure as the aluminum matrix [10]. Al_3Zr may also exert an important influence on certain mechanical properties through their effects both on the response of some alloys to ageing treatments, and on dislocation substructures formed as a result of plastic deformation [11]. The objective of this research work was to study the influence of Zr additions and ageing time on the some mechanical properties of 6063 alloy such as Vickers hardness, tensile strength, and impact toughness.

2. Experimental Work

The present study was carried out on 6063 aluminum alloy, the chemical composition of the alloys are indicated in Table 1. Alloys were prepared by melting aluminum at 675°C then remaining for 5 minutes after each element addition and then casting in especially design. Steel die which is designed and manufactured with dimension and tolerance with respect to the required ingot. The cast samples were machined to standard Vickers hardness, tensile and impact test specimens. The machined samples were homogenized at 560°C held at this temperature for 2h, and cooled in the furnace, then it was solution heat treated at temperature 530°C in an electric heat treatment furnace, soaked for 1h at this temperature and then rapidly quenched in water at room temperature. The quenched specimens were then artificially aged at 175°C for different time periods (2-10)h before cooling in air. The specimens were then subjected to Vickers hardness, tensile and impact testing.

Table (1) The chemical composition of prepared alloys

Name of alloy	Si Wt%	Mg Wt%	Fe Wt%	Cu Wt%	Zr Wt%	Al Wt%
Alloy 1	0.70	0.50	0.20	0.08	--	Bal.
Alloy 2	0.70	0.50	0.20	0.08	0.10	Bal.
Alloy 3	0.70	0.50	0.20	0.08	0.15	Bal.
Alloy 4	0.70	0.50	0.20	0.08	0.20	Bal.
Alloy 5	0.70	0.50	0.20	0.08	0.25	Bal.
Alloy 6	0.70	0.50	0.20	0.08	0.30	Bal.

2.1 Vickers Hardness Test

Microhardness test was measured of the specimens by using Vickers tester type (Microhardness tester Hv-1000) .For achieving of the hardness test load 100g was used for 10s. Before subject specimens to hardness tests, appropriate grinding and polishing were done. The form of samples as cylindrical bar with a height of 7mm and a diameter of 15mm as shown in Figure 1.

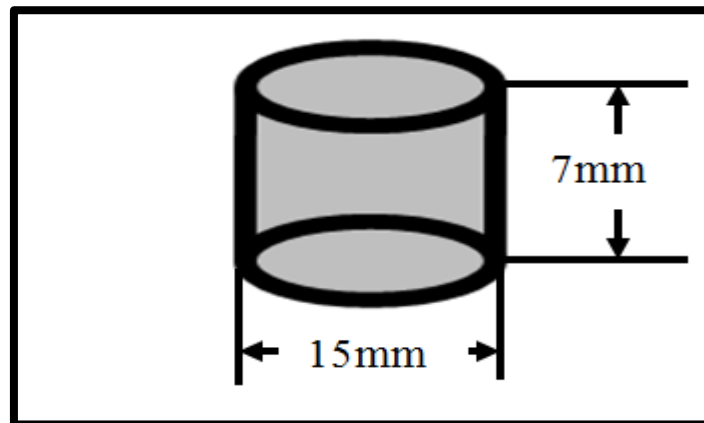

Fig.(1) Vickers hardness test specimen

2.2 Tensile Test

Standard test bars shown in Figure 2 were machined according to the ASTM B 557M-2a standard with a gauge length($g=30mm$), diameter($d=6mm$), radius of fillet($r=6mm$) and the length of reduced section($a=36mm$). The specimens were tested to evaluate the tensile strength at room temperature using the tensile equipment type (Instorn 1195, made in Germany).

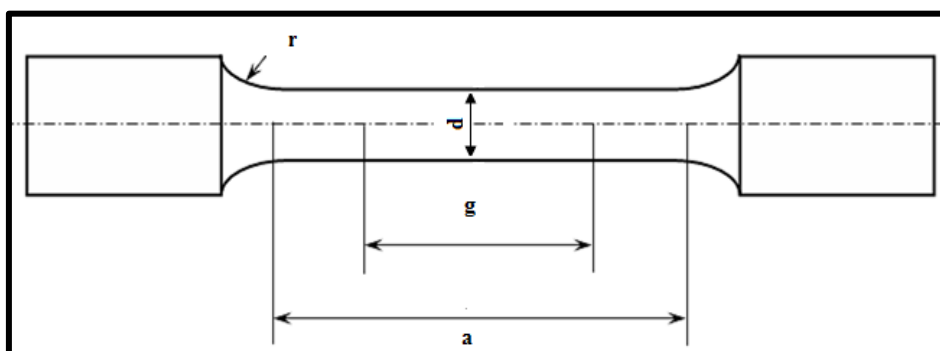

Fig.(2) Tensile test specimen

2.3 Impact Toughness Test

Impact testing was performed on Charpy testing machine using (55*10*10) mm with 45° V notch, 2mm deep with 0.25 mm root radius as shown in Figure 3. The equipment that used in this test was (FIT-300(N)) type.

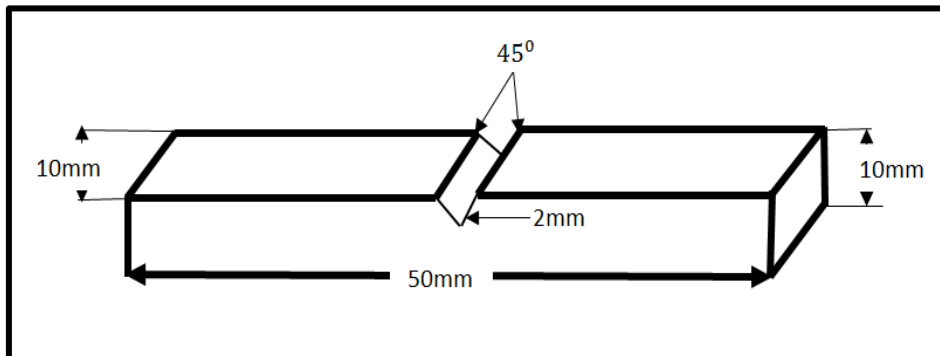

Fig.(3) Impact test specimen

3. Results and Discussion

3.1 Vickers Hardness Results

The influence of ageing time on Vickers hardness is shown in Figure 4. It was observed from the Figure that Vickers hardness of the specimens increases for all alloys until reaching maximum value as the ageing time increased from 2h to 6h due to the formation of precipitates which, impede the movement of dislocations. Then Vickers hardness value decreases upon further ageing time due to over-ageing of the specimens. It is concluded that Vickers hardness increases with increasing ageing time for a certain limit of ageing time. It can be seen that the ageing time 6h gives the maximum Vickers hardness.

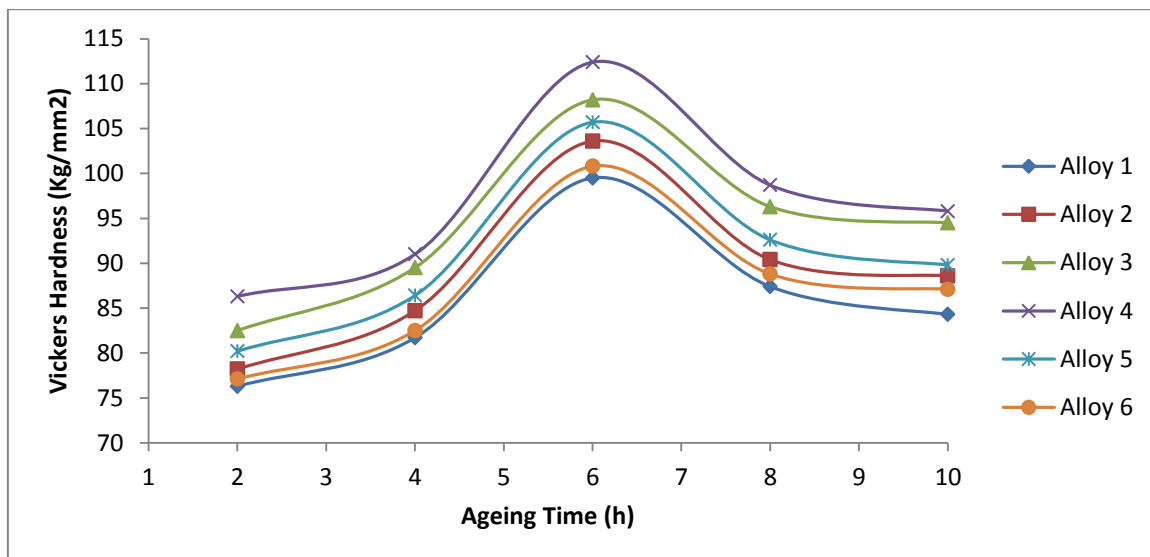

Fig.(4) Effect of ageing time on the Vickers hardness

Figure 5 shows the variation of Vickers hardness of the 6063 alloy as a function of weight percent Zr at various ageing time (2,4,6,8,and 10)h. It could be seen from this Figure that Vickers hardness increases with increasing of Zr additions for all ageing time because Zr addition decreases the average grain size of the 6063 alloy. This is due to the increase of Al₃Zr particles (which act as potent nucleating sites for α -Al phase) as the addition level of Zr increases [12]. It can be noted that the addition of 0.2% Zr gives the maximum Vickers hardness and addition of Zr beyond 0.2% result in slight increase in Vickers hardness because slight increase in the average grain size of the 6063

alloy. It is concluded that addition of 0.2 wt.% Zr to the 6063 alloy improves Vickers hardness by 12.96% at ageing time 6h.

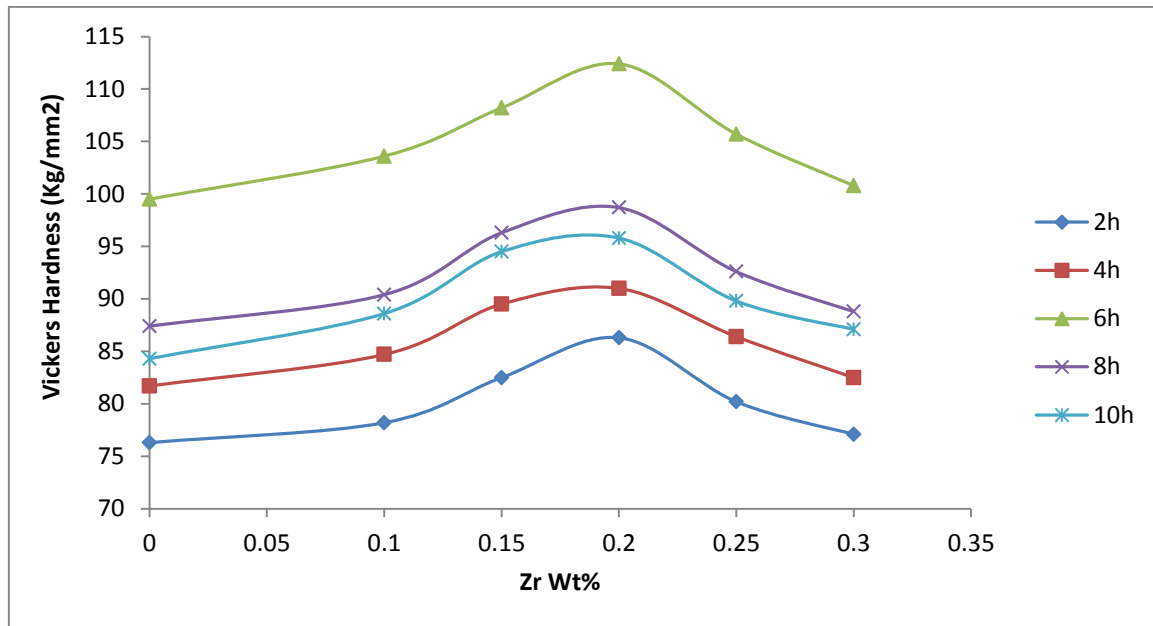

Fig.(5) Effect of Zr additions on Vickers hardness

3.2 Tensile Results

Figure 6 shows the variation of tensile strength with ageing time. It is seen that the tensile strength of the alloys increases with increasing of ageing time from 2h to 6h, then, the tensile strength of all alloys decreases with further ageing time, it may be due to over-ageing. By comparison with Figure 4, it can be seen the Vickers hardness is proportional linearly with the tensile strength.

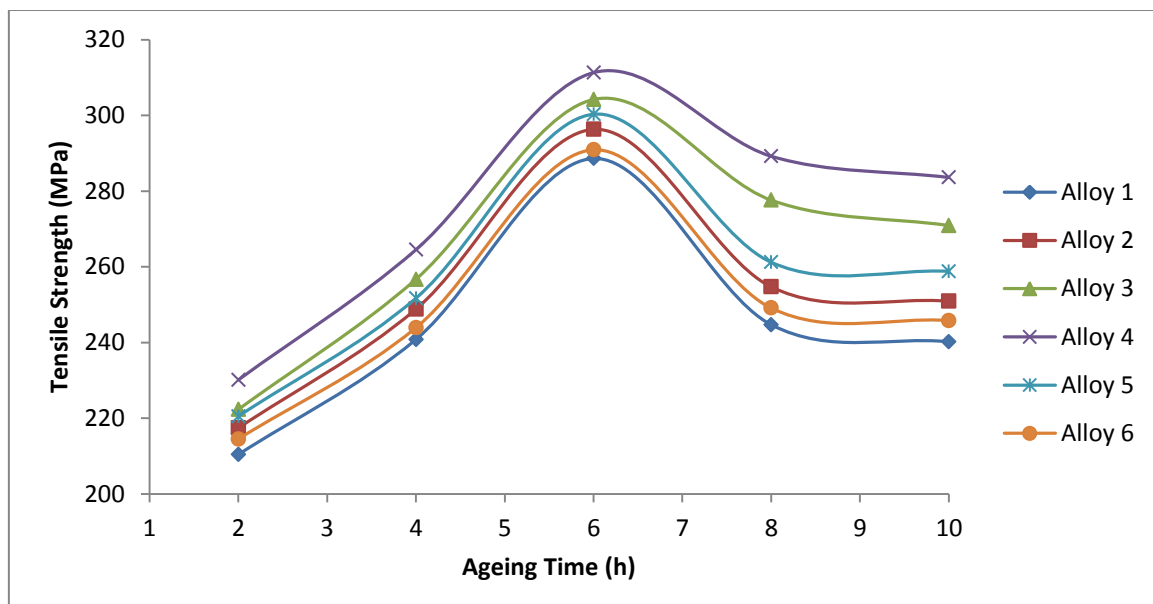

Fig.(6) Effect of ageing time on the tensile strength

Figure 7 shows the variation of tensile strength of the 6063 alloy as a function of weight percent of Zr at various ageing time (2,4,6,8,and 10)h. It could be seen from this Figure that tensile strength increases with increasing of Zr additions, but the additions above 0.2% gives slight

increase in tensile strength. It is concluded that addition of 0.2 wt.% Zr to the 6063 alloy improves tensile strength by 7.86% at ageing time 6h.

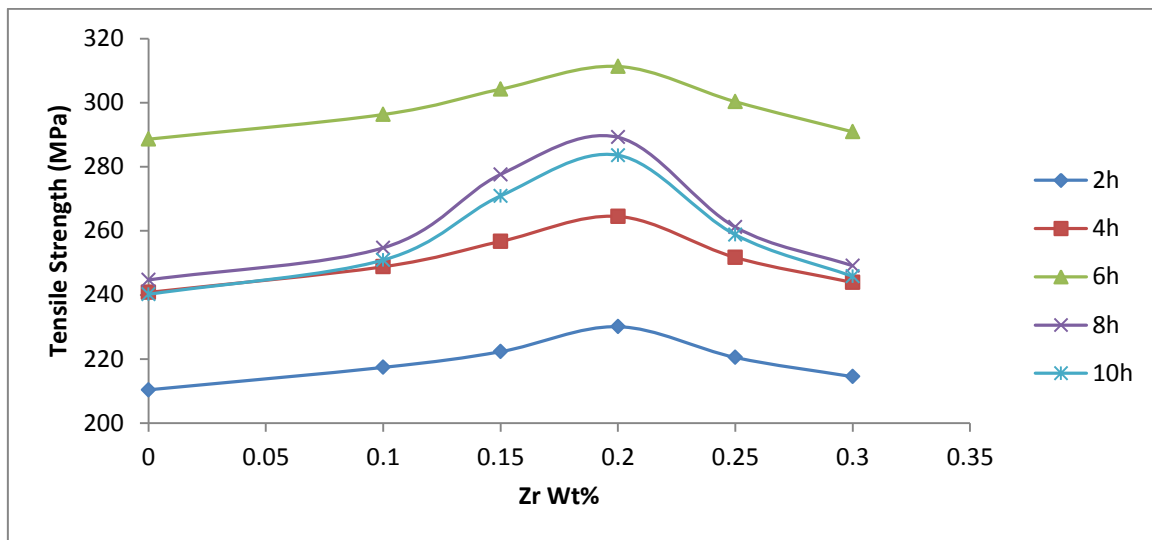

Fig.(7) Effect of Zr additions on the tensile strength

3.3 Impact Toughness Results

Figure 8 shows the energy absorbed as a function of artificial ageing time, it is observed from the Figure that the absorbed energy decreases with increasing of ageing time from 2h to 6h for all alloys then it increases with increasing of ageing time from 8h to 10h. By comparison with Figure 4, it can be seen the specimens with the highest Vickers hardness have the lowest impact toughness, i.e. Vickers hardness is inversely proportional to the impact toughness.

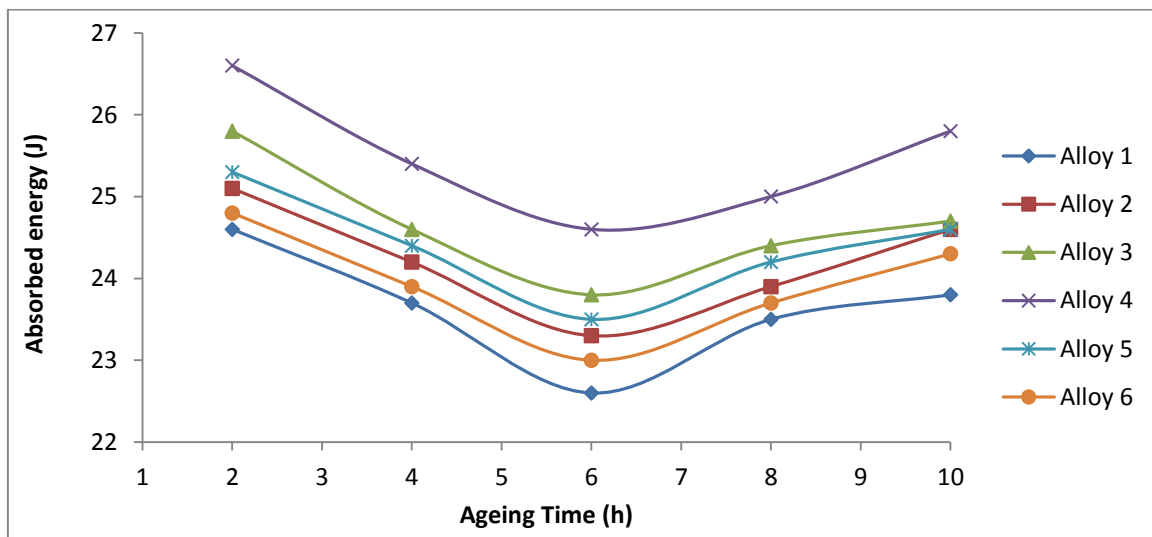

Fig.(8) Effect of ageing time on the impact toughness

Figure 8 shows the variation of energy absorbed of the 6063 alloy as a function of weight percent Zr at various ageing time (2,4,6,8,and 10)h. It could be seen that the energy absorbed increases with increasing of Zr additions for all ageing time and it is observed that the maximum energy absorbed to be when addition 0.2wt.% Zr at ageing time 2h, while the additions higher than 0.2wt.% Zr give small increase in energy absorbed. It is concluded that addition of 0.2 wt.% Zr to the 6063 alloy improves energy absorbed by 8.13% at ageing time 2h.

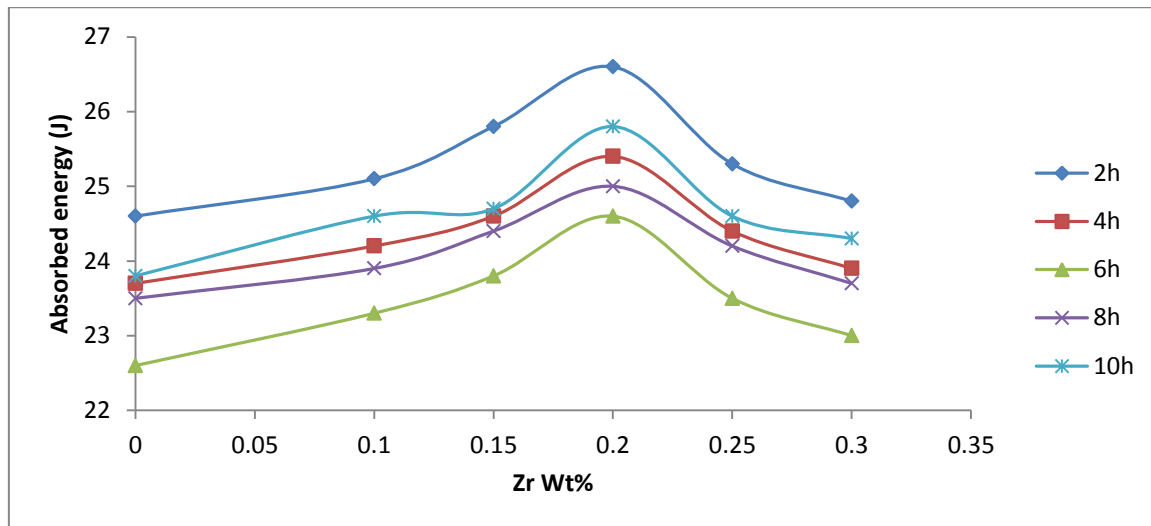

Fig.(9) Effect of Zr additions on the impact toughness

4. Conclusions

The effect of Zirconium additions and ageing time on the some mechanical properties of (6063) aluminum alloy was investigated and the following results were obtained:

1. Addition of 0.2 wt.% Zr to the 6063 alloy improves Vickers hardness and tensile strength by 12.96% and 7.86% respectively at ageing time 6h and improves impact toughness by 8.13% at ageing time 2h.
2. Vickers hardness and tensile strength increase with increasing of ageing time for a certain limit of ageing time, i.e. Vickers hardness is proportional linearly with the tensile strength.
3. Impact toughness decreases with increasing of ageing time up to 6h and increases with ageing time exceeding 6h.
4. The specimens with the highest Vickers hardness have the lowest impact toughness, i.e. Vickers hardness is inversely proportional with the impact toughness.
5. The additions higher than 0.2wt.% Zr give slight increase in studied properties of 6063 alloy.

References

1. O. P. Gbenebor, M. Abdulwahab, O. S. I. Fayomi, and A. P.I. Popoola, "Influence of inoculant addition and cooling medium on the mechanical properties of AA6063-Type Al-Mg-Si alloy", Journal of Chalcogenide Letters ,Vol. 9, No. 5,pp. 201 – 211,2012.
2. M. Abdulwahab, I. A. Madugu, F. Asuke, O.S.I. Fayomi, and F. A. Ayeni , "Effect of thermal ageing treatment on the mechanical properties of antimony-modified A356.0-type Al-Si-Mg alloy", Journal of Mater. Environ.Sci. 4 (1),pp.87-92,2013.
3. S. Karabay, M. Zeren, M. Yilmaz, "Investigation of extrusion ratio effect on mechanical behaviour of extruded alloy AA-6101 from the billets homogenised-rapid quenched and as-cast conditions", Journal of Materials Processing Technology 160,pp.138-147, 2004.
4. G. Mrówka-Nowotnik, J. Sieniawski, "Influence of heat treatment on the microstructure and mechanical properties of 6005 and 6082 aluminum alloys", Journal of Achievements in Mechanical & Materials Engineering", Gliwice – Wisla, , pp.447-450, 2005.
5. M. Warmuzek, G. Mrówka-Nowotnik, J. Sieniawski, "Influence of the heat treatment on the precipitation of the intermetallic phases in commercial AlMn1FeSi alloy", Journal of Materials Processing Technology 157-158,pp.624-632, 2004.

6. G. M. Nowotnik, "Influence of chemical composition variation and heat treatment on microstructure and mechanical properties of 6xxx alloys", Journal of Archives of Materials Science and Engineering, Vol.46 , No.2,pp.98-107,2010.
7. A.K. Mukhopadhyay, " Microstructure and Properties of High Strength Aluminum Alloys for Structural Applications", Journal of Transactions of the Indian Institute of Metals, Vol. 62, No. 2, pp. 113-122,2009.
8. Z. Zhuo and C. Kang-hua, " Effect of Yb addition on strength and fracture toughness of Al-Zn-Mg-Cu-Zr aluminum alloy " , Journal of Transactions of Nonferrous Metals Society of China, 2008.
9. D. Srinivasan and K. Chattopadhyay, " Metastable Phase Evolution and Hardness of Nanocrystalline Al-Si-Zr Alloys " , Journal of Mater. Sci. Eng. A, 304, pp.534-539, 2001.
10. S. Yan, " Strengthening aluminum by zirconium and chromium ", MSC Thesis, Worcester Polytechnic Institute , Materials Science and Engineering, Worcester, Massachuestts, USA ,2012 .
11. I. J. Polmear "Light Alloys From Traditional Alloys to Nanocrystals", printed and bound in Great Britain, published by Elsevier Ltd, fourth edition, 2007.
12. A.E. Mahmoud, M. G. Mahfouz, and H. G. Gad- Elrab, "Influence of zirconium on the grain refinement of Al 6063 alloy", Journal of Engineering Research and Applications, Vol. 4,No.7,pp.188-194,2014.